

Article number: 437900030

Description: Rota-fix shaft-hub connection SA 30

Measures

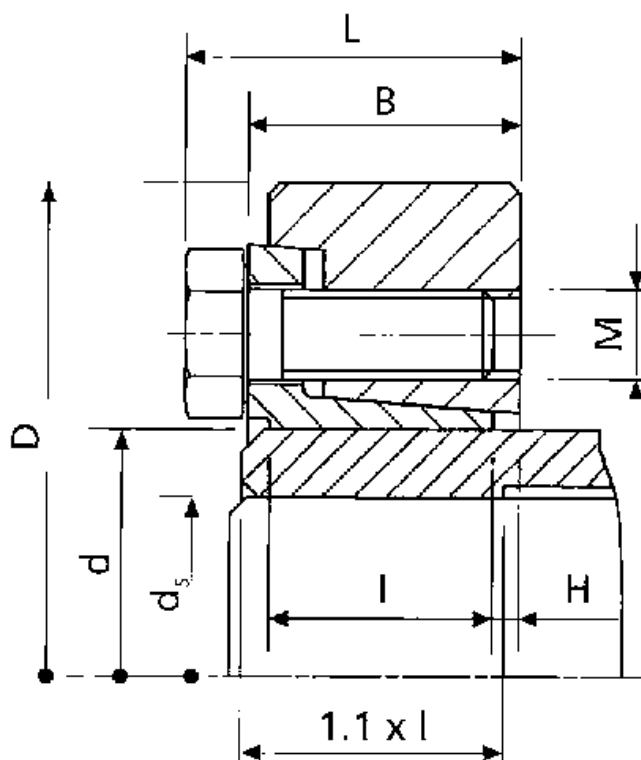

B mm	= 20.0	M mm	= M6
d H8 mm	= 30	T N m torque	= 370
D mm	= 60.0	Ts N m bolt tightening torque	= 13
ds mm	= 24		
F kN torque	= 31		
H	= 2.0		
I mm	= 17.0		
L mm	= 24.0		